

59 912 853

Durchführung nach
DVGW Arbeitsblatt W 551

 HANSA

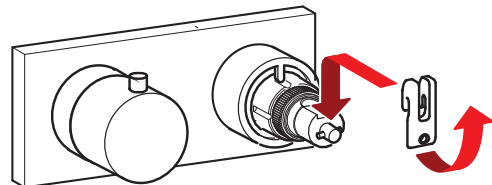
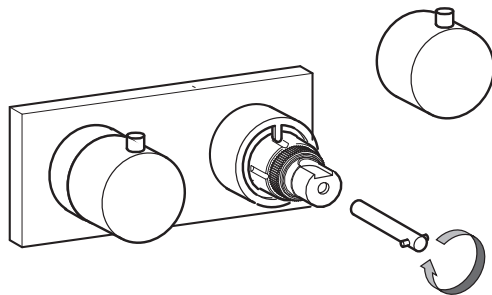
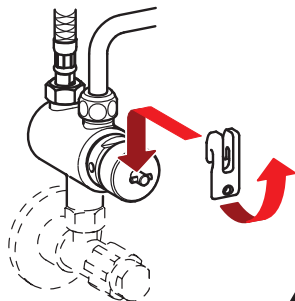
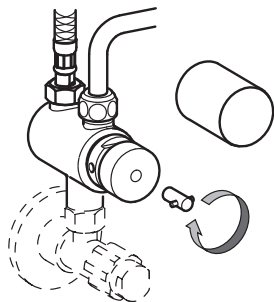

Während des Spülens besteht die Gefahr der
Verbrühung, da die Auslauftemperatur auf
über 70°C steigt!

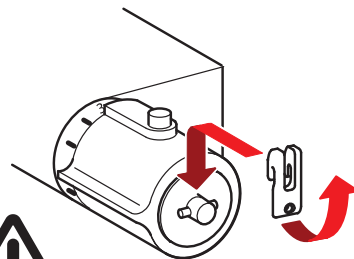
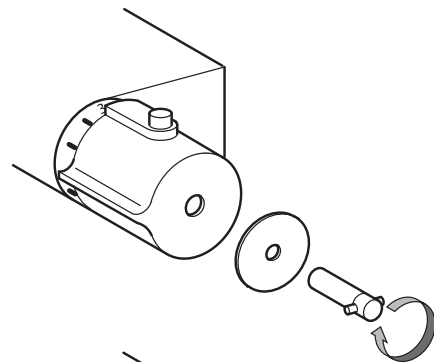
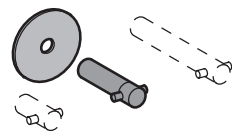

A022184/1114