

INSTALLATION MANUAL

MONTAGEANLEITUNG

INSTRUCTIONS DE MONTAGE

ISTRUZIONI PER IL MONTAGGIO

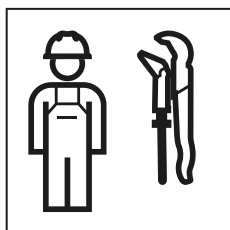

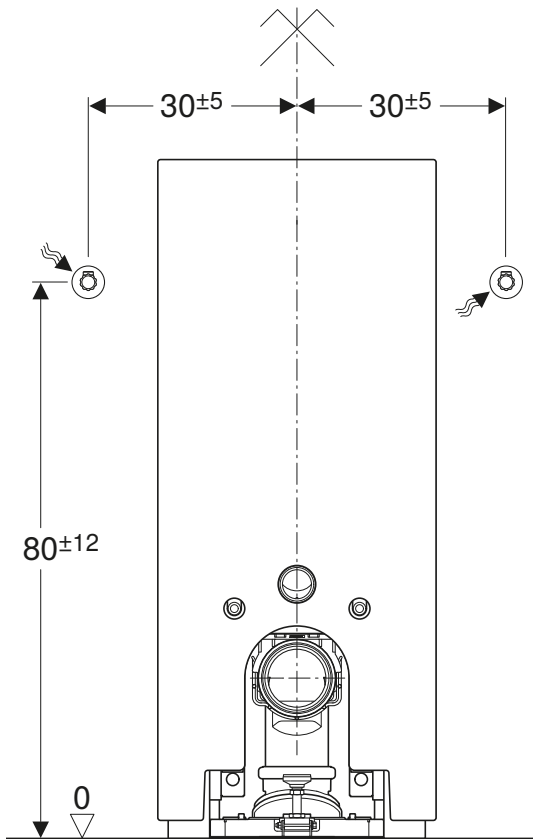

1

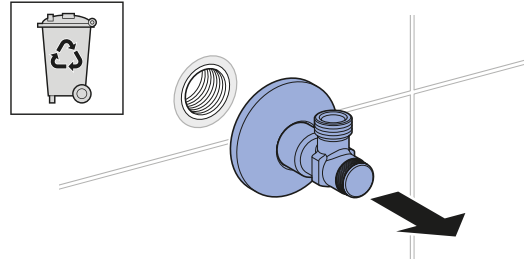

2

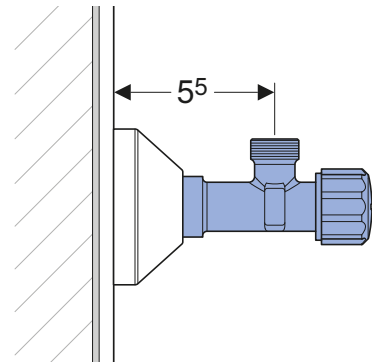
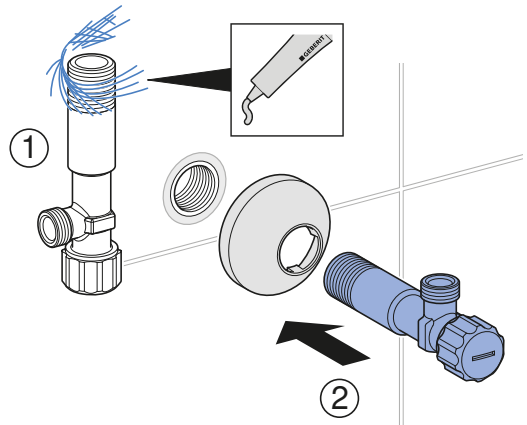

3



2

1

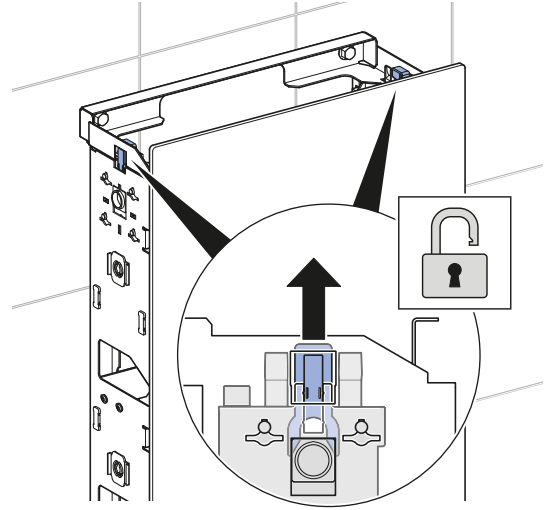

2

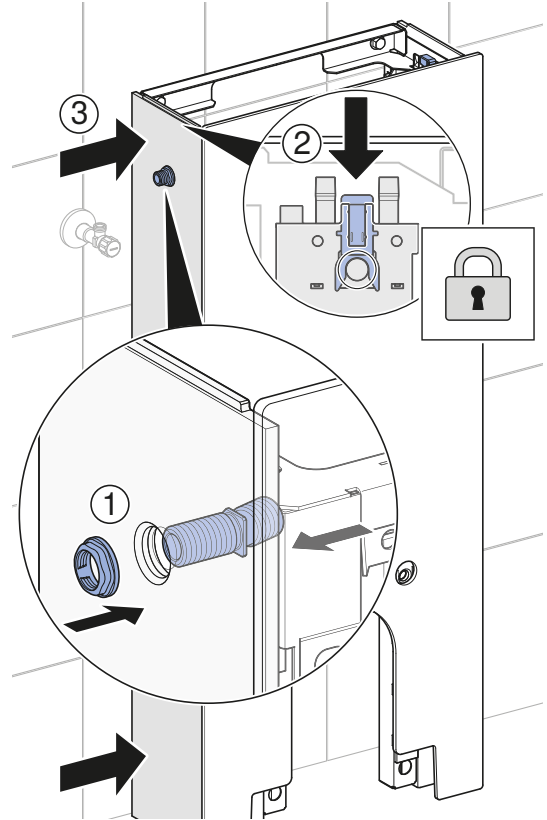

3

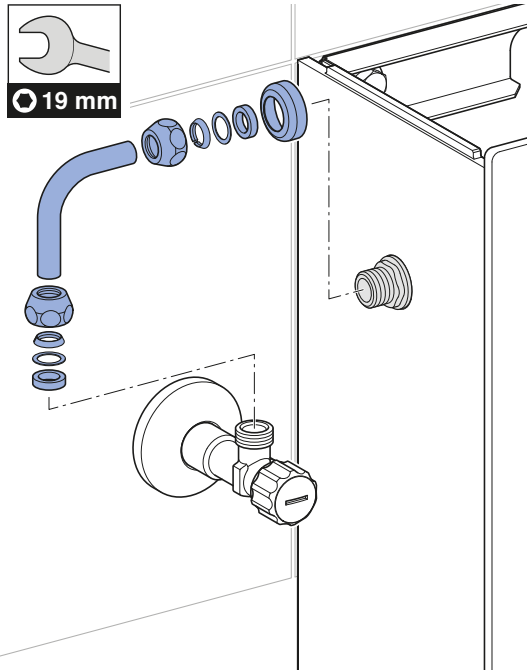

5

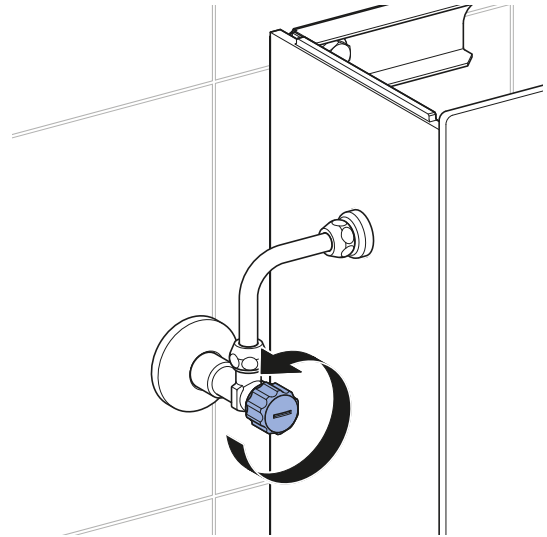

4

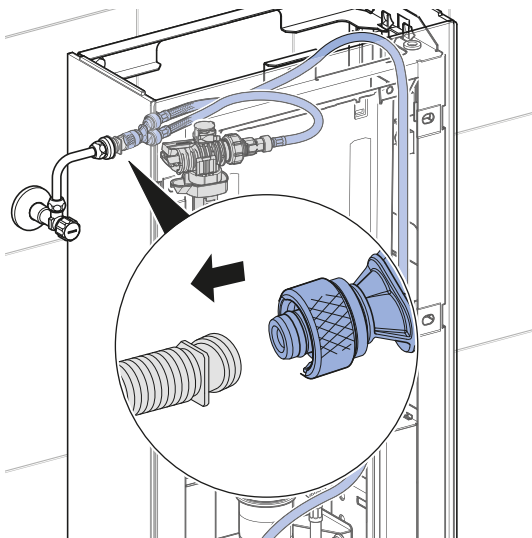

6

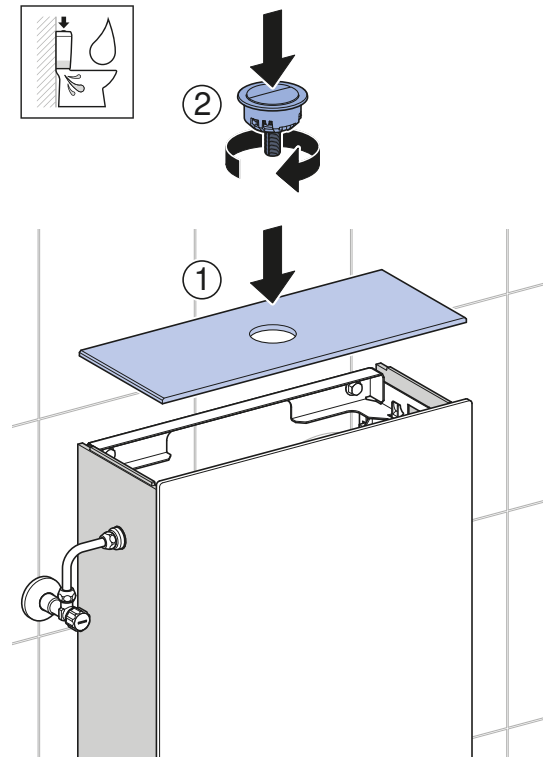

Geberit International AG
 Schachenstrasse 77, CH-8645 Jona
 documentation@geberit.com
 www.geberit.com

