

# L-Cube

# # LC 7652

## Montageanleitung

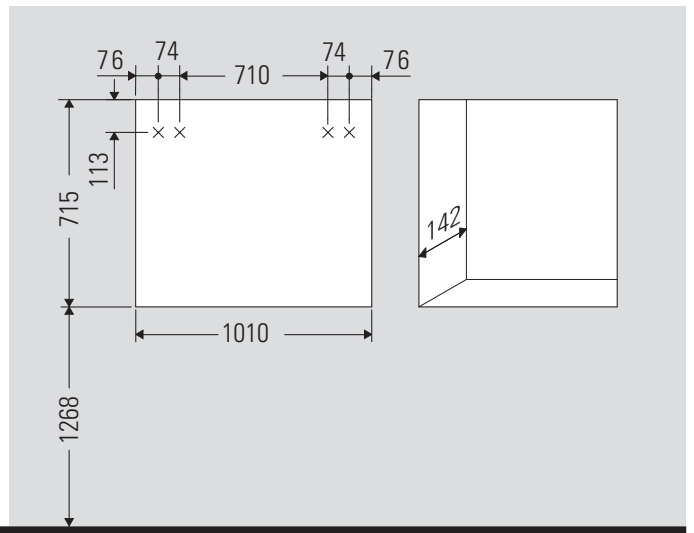
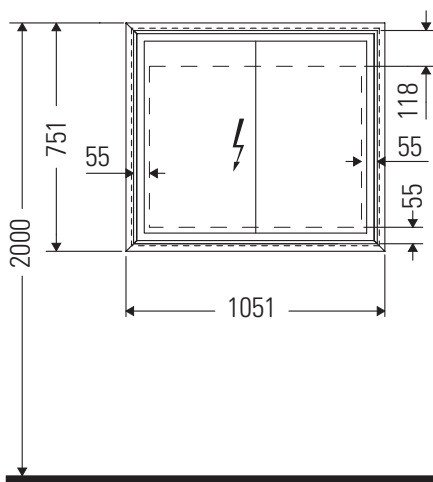

Ausschnittgröße für Einbauschränke

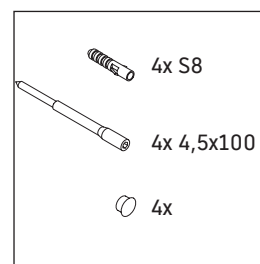
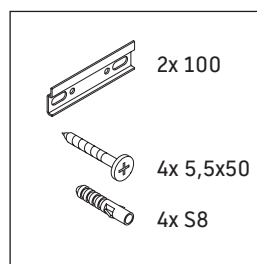
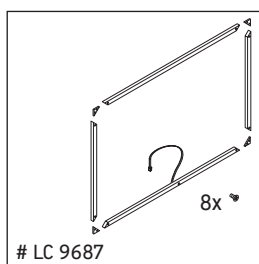
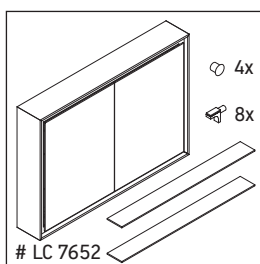

Montageanleitung für Badmöbel mit Stromführung beachten.

## Verwendungshinweise

Die Badmöbelserie entspricht den gültigen Normen und Richtlinien zum Zeitpunkt der Auslieferung und ist für den Einsatz in Bädern konzipiert.

Eine direkte Benetzung mit Wasser z. B. beim Duschen ist zu vermeiden.

Stromanschluss 110 V – 230 V muss bauseits vorhanden sein.

Technische Verbesserungen und optische Veränderungen an den abgebildeten Produkten behalten wir uns vor.



# LC 9687

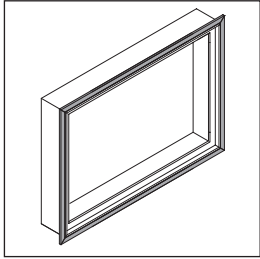

1 # LC 9687

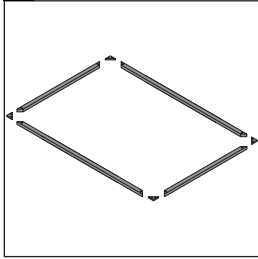

2 # LC 9687

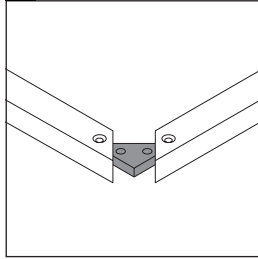

3 # LC 9687

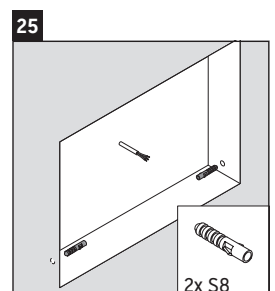
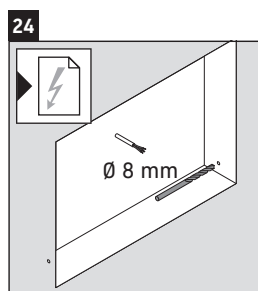
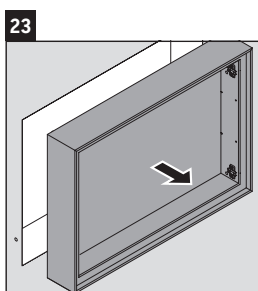
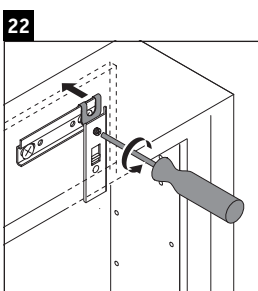
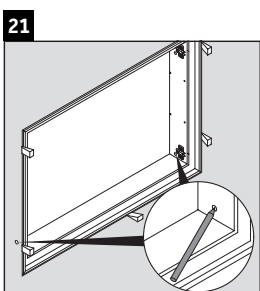
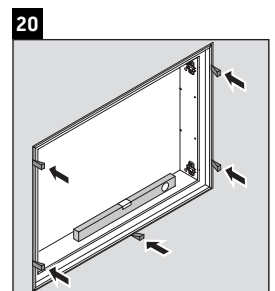
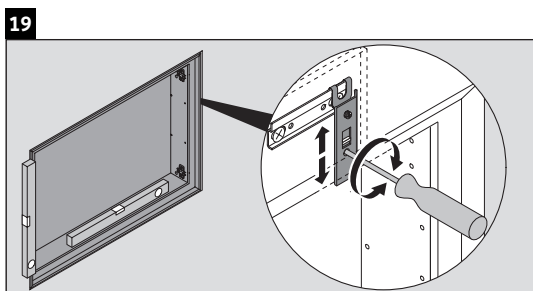
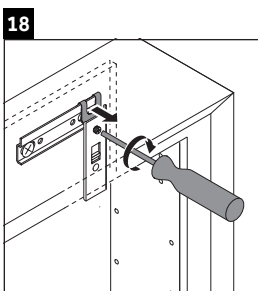
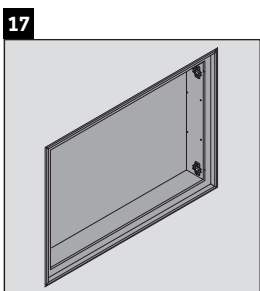
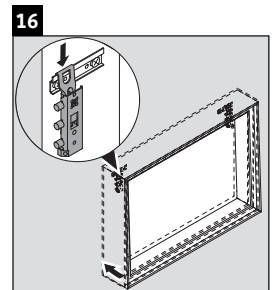
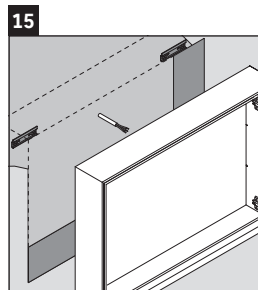
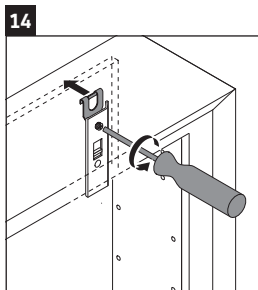
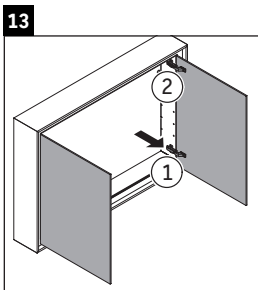
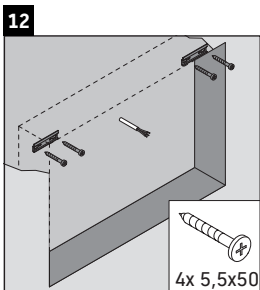
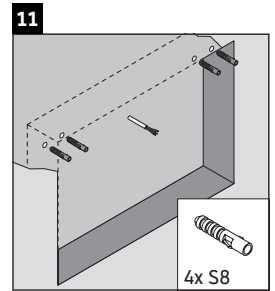
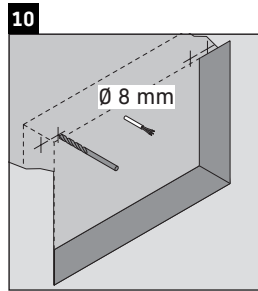
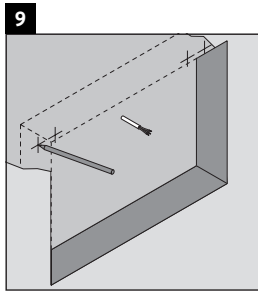
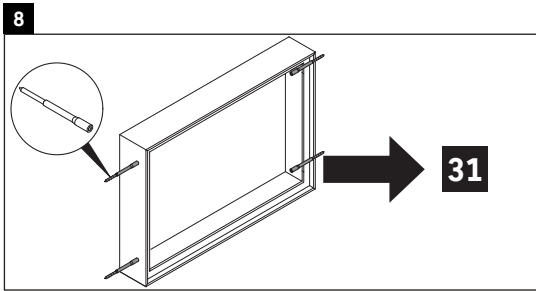
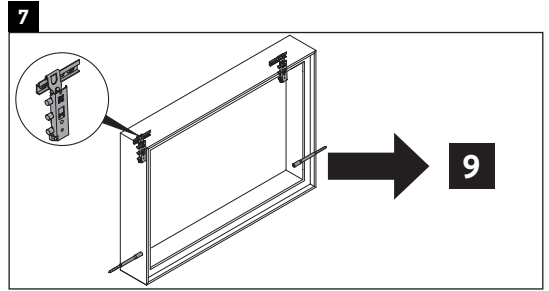
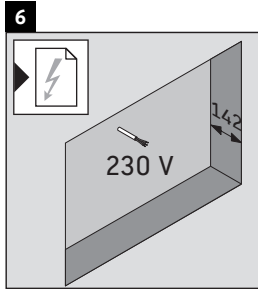
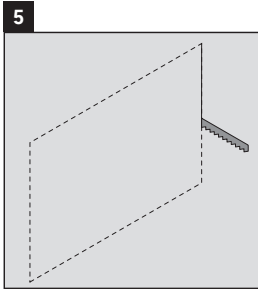
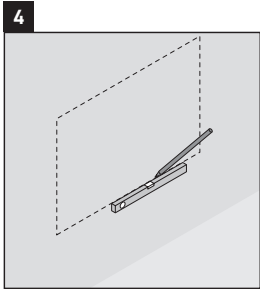
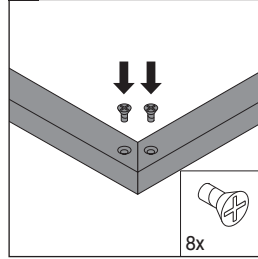

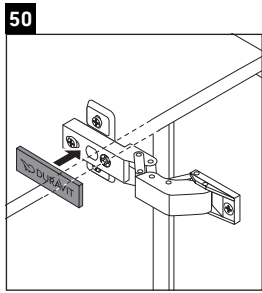
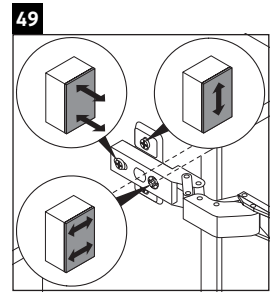
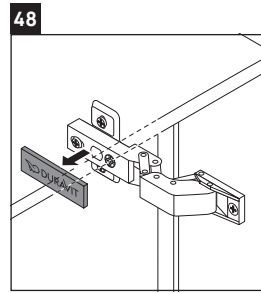
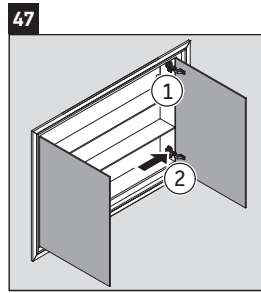
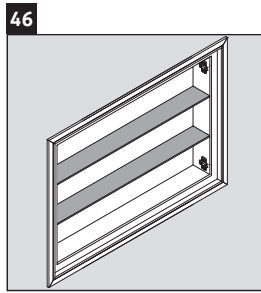
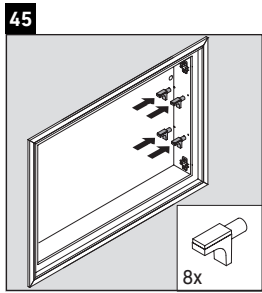
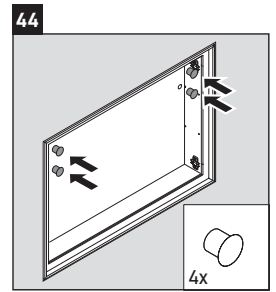
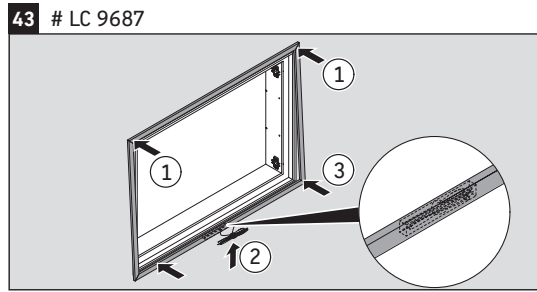
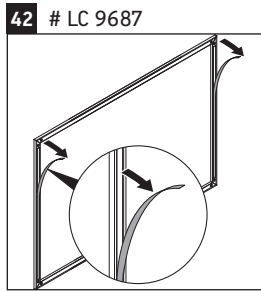
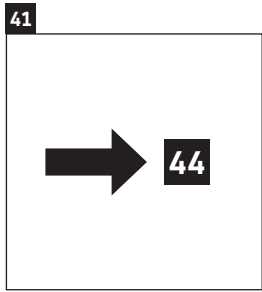
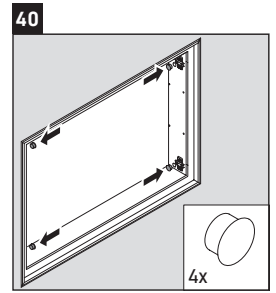
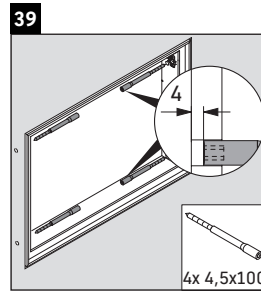
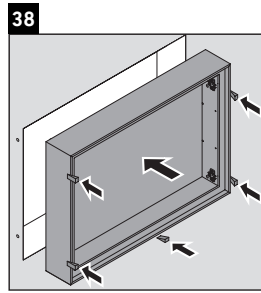
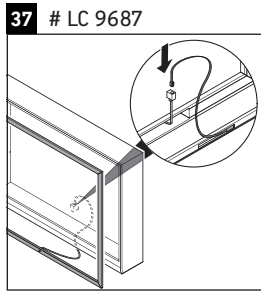
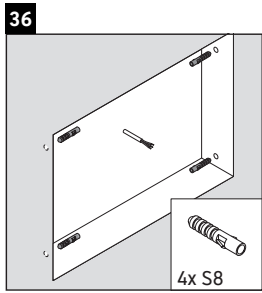
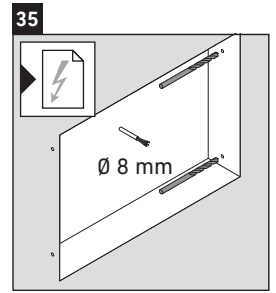
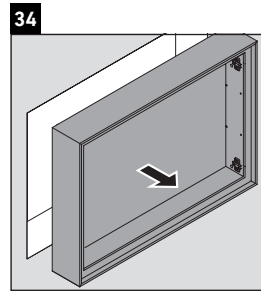
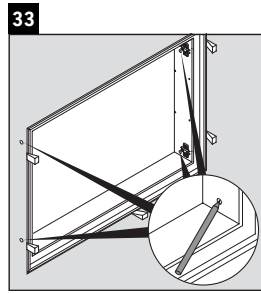
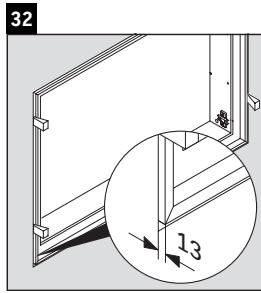
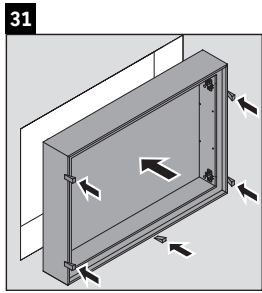
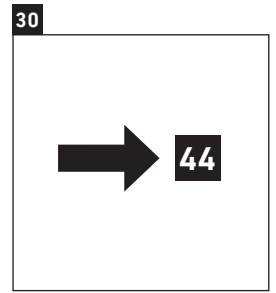
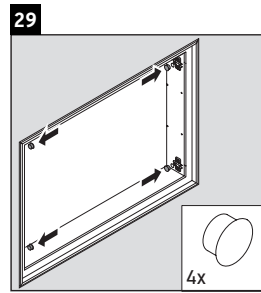
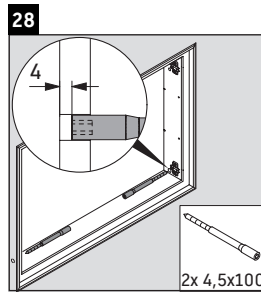
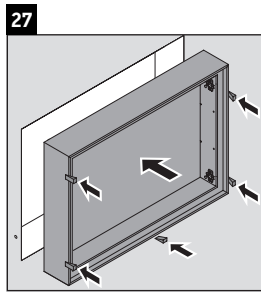
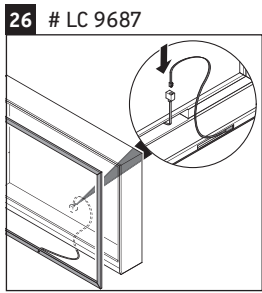

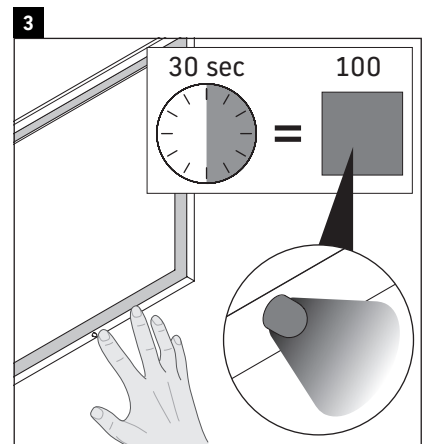
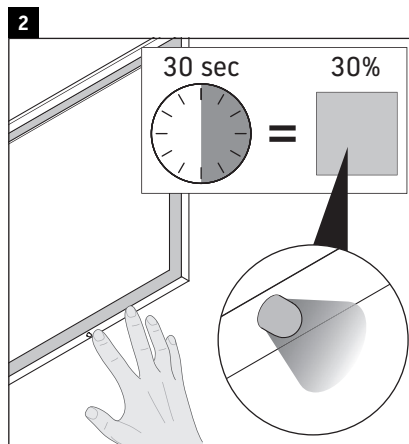
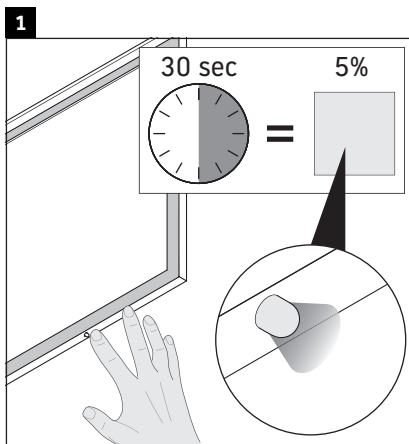
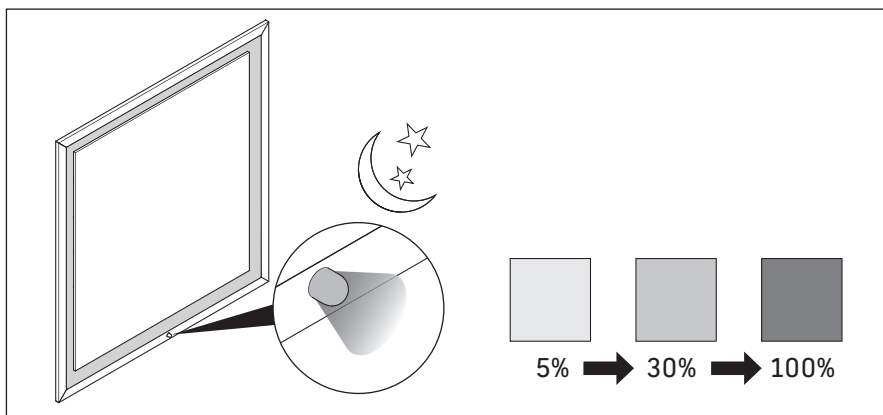
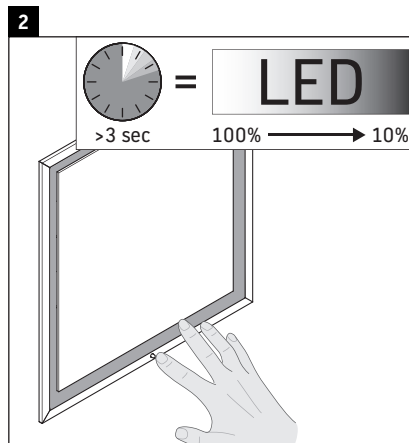
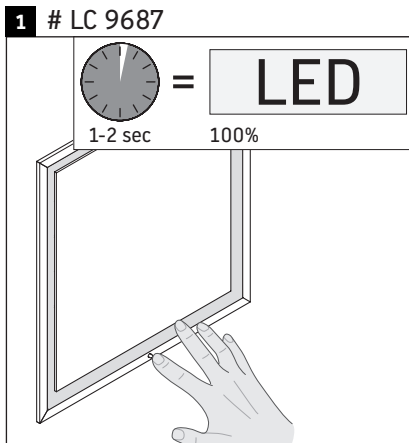

---

## Montageanleitung für Badmöbel mit Stromführung



Sicherheit

2



Elektroinstallation

3



## Sicherheit

### Bestimmungsgemäße Verwendung

Die Montageanleitung ist Bestandteil des Duravit Produkts und richtet sich an Personen, die die Elektroinstallation für das Produkt durchführen. Die Montageanleitung muss sorgfältig gelesen werden und jederzeit verfügbar sein.

### Zielgruppe und Qualifikation

Die Elektroinstallation darf nur von ausgebildeten Elektrofachkräften durchgeführt werden.

### Schutzart von Duravit Produkten

Die Schutzart von stromführenden Duravit Produkten entspricht mindestens dem Standard IP 44.

### Schutzklassen der Leuchten

Schutzklasse	Anschlussleitung
I	H05VV-F, 3x 1,5 qmm
II	H03VV-F, 2x 0,75 qmm

### Richtlinien und Normen

Duravit Produkte entsprechen den Richtlinien der CE-Kennzeichnung:



### Zeichen und Symbole

Symbol	Bedeutung
>	Handlung erforderlich

### Entsorgung

- Produkt nicht im Hausmüll entsorgen. Produkte mit diesem Symbol sind gemäß WEEE-Richtlinie über die örtlichen Sammelstellen für Elektroaltgeräte zu entsorgen.



### Sicherheitshinweise

#### Lebensgefahr

Der Kontakt mit Strom führt zu elektrischem Schlag.

- > Elektroinstallation gemäß nationaler, europäischer und internationaler Richtlinien und Normen durchführen.
- > Schutzzonen für Feuchträume gemäß länderspezifischer Normen, örtlichen Vorschriften und Niederspannungsrichtlinien einhalten.
- > Bei Feuchträumen oder sonstigen, speziell ausgewiesenen Räumlichkeiten den elektronischen Anschluss über einen GFI-Sicherungsautomaten durchführen.
- > Vor der Installation elektrische Komponenten vom Stromnetz trennen.
- > Prüfen, ob alle Komponenten spannungsfrei sind.
- > Verhindern, dass die Stromzufuhr versehentlich zugeschaltet wird.

#### Eindringen von Fremdkörpern und Wasser

Fremdkörper oder Wasser im Betriebsmittel führen zu einem Kurzschluss, der Produktschäden verursachen kann.

- > Die Schutzzonen für Duravit Produkte beachten.

#### Schutzzonen

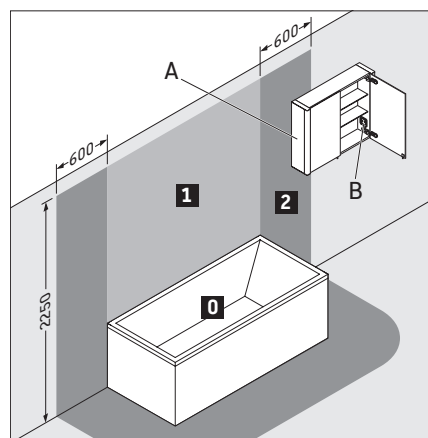

**A** Spiegelschrank mit IP 44 darf in Zone 2 hineinragen.

**B** Eine im Spiegelschrank vorhandene Steckdose muss außerhalb der Zonen montiert sein.

### Energieeffizienzklasse

- Dieses Produkt enthält eine Lichtquelle der Energieeffizienzklasse F.



## Elektroinstallation für Schutzklasse I

### Stromanschluss

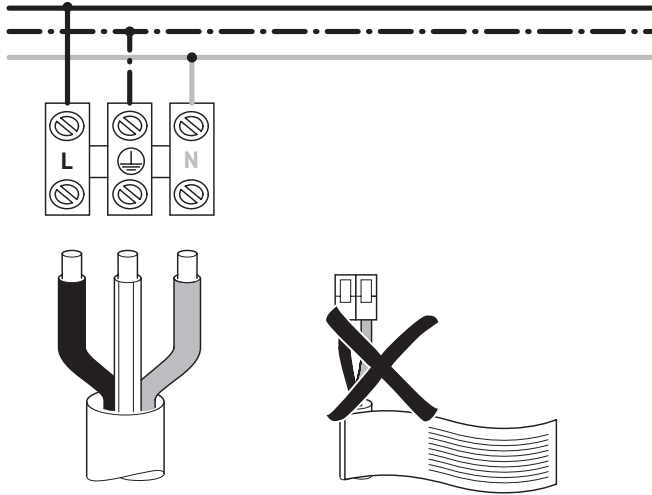

### Optionaler Anschluss eines externen Tasters

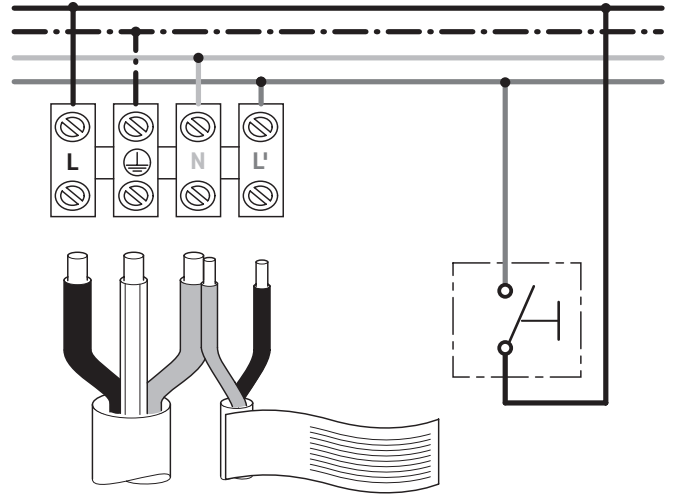

## Elektroinstallation für Schutzklasse II

### Stromanschluss

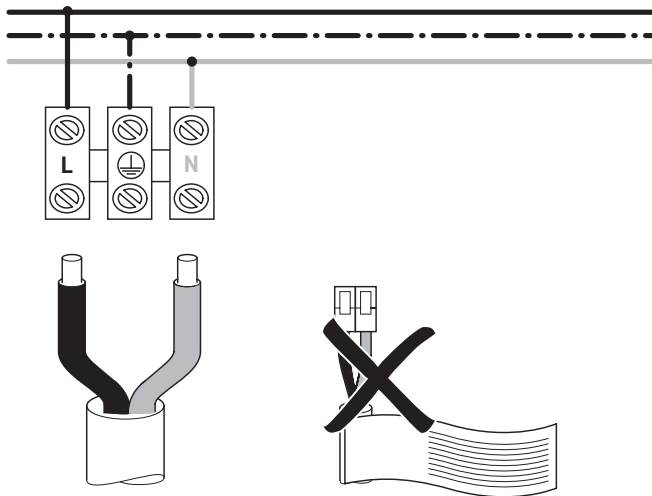

### Optionaler Anschluss eines externen Tasters

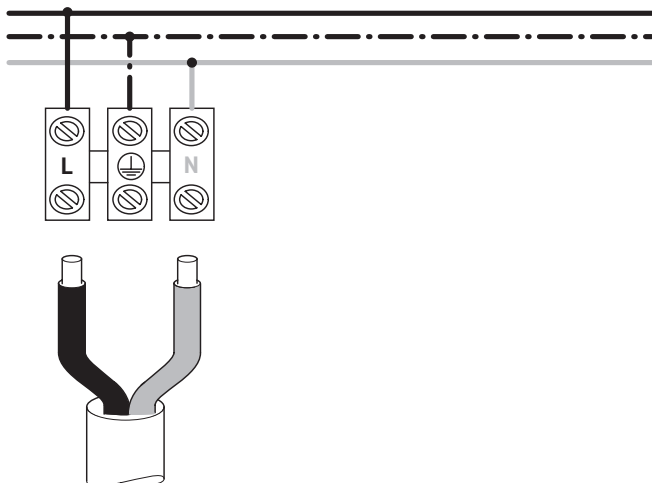
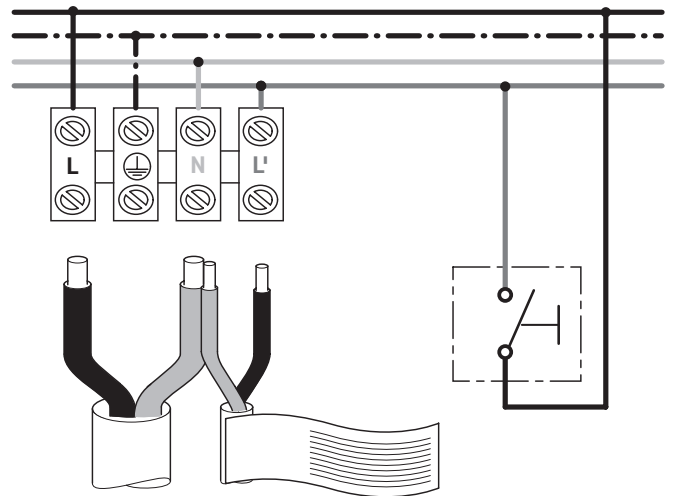

**DURAVIT AG**  
P.O. Box 240  
Werderstr. 36  
78132 Hornberg  
Germany  
Phone +49 7833 70 0  
Fax +49 7833 70 289  
info@duravit.com  
www.duravit.com

